



## **3A Synchronous Buck 2 Cells Li-ion Charger**

### **DESCRIPTION**

The BC912 is a 3A Li-Ion battery charger. It utilizes a 500 KHz synchronous buck converter topology to reduce power dissipation during charging. Low power dissipation, an internal MOSFET allow a physically small charger that can be embedded in a wide range of handheld applications. The BC912 includes complete charge termination circuitry, automatic recharge and a  $\pm 1\%$  8.4V float voltage. Battery charge current, charge timeout and end-of-charge indication parameters are set with external components. Additional features include shorted cell detection; temperature qualified charging and overvoltage protection. The BC912 is available in a ESOP8 and DNF10 package

### **FEATURES**

- Input voltage range 4V~22V
- Dynamic input current allocation for maximum charging rate
- 3A Maximum Charge Current
- No External MOSFETs and Blocking Diode Required
- Efficiency up to 95%
- Constant-Current/Constant-Voltage Operation with Thermal Regulation to Maximize Charge Rate Without Risk of Overheating
- Optional Battery Temperature Monitoring Before and During Charge Automatic Sleep Mode for Low-Power
- Over Current Protection
- Consumption Available in ESOP8 and DFN10
- RoHS Compliant and 100% Lead (Pb)-Free

### **APPLICATIONS**

Portable Media Players  
Cellular and Smart mobile phone  
PDA/DSC  
Handheld Battery-Powered Devices  
Handheld Computers  
Charging Docks and Cradles



## 3A Synchronous Buck 2 Cells Li-ion Charger

### PACKAGE AND APPLICATION

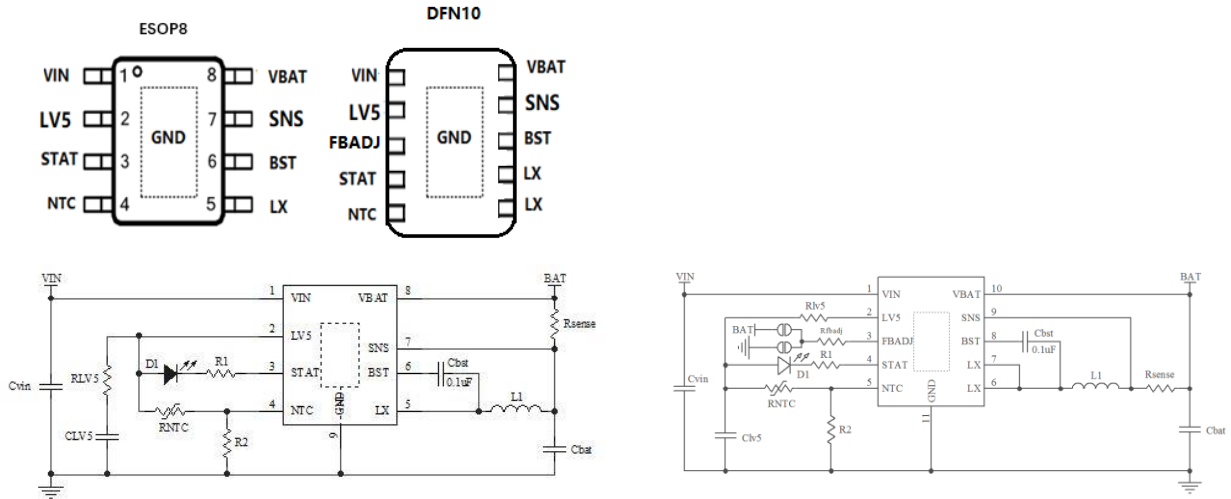

### ORDERING INFORMATION

Part Number	Package Type	Package Qty	Op Temp(°C)
BC912	ESOP8	4000	-40~85
BC912	DFN10	4000	-40~85

### MARK INFORMATION

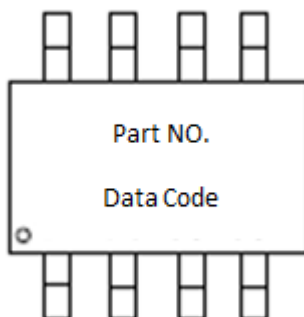



## 3A Synchronous Buck 2 Cells Li-ion Charger

### ABSOLUTE MAXIMUM RATINGS <sup>(1)</sup>

Over recommended operating free-air temperature range (unless otherwise noted)

PARAMETER		MIN	MAX	UNIT
VIN /VBAT/SNS/LX to GND	VIN, VBAT, SNS,LX	-0.3	25	V
BST to LX	BST,LX	-0.3	6.5	
ALL OTHER PINS to GND	VIN, BAT, SNS, LX, BST	-0.3	13	V
ESD rating, Human Body Model (HBM)	VIN		2	kV
	BAT, SNS, LX, GND ,BST		3	
ESD rating, Charging Device Model (CDM)			200	V
Operating Junction Temperature	T <sub>J</sub>	-40	125	°C
Storage Temperature Range	T <sub>stg</sub>	-65	150	

- (1) Stresses beyond those listed under *Absolute Maximum Ratings* may cause permanent damage to the device. These are stress ratings only, and functional operation of the device at these or any other conditions beyond those indicated under *Recommended Operating Conditions* is not implied. Exposure to absolute-maximum-rated conditions for extended periods may affect device reliability.

### THERMAL CHARACTERISTICS

over operating free-air temperature range (unless otherwise noted)

THERMAL METRIC( $\theta_{JA}$ )			UNIT
ESOP 8	Package thermal impedance <sup>(1)</sup>	45	°C/W
DFN8	Package thermal impedance <sup>(1)</sup>	65	°C/W

- (1) The package thermal impedance is calculated in accordance with JESD 51-7.



## 3A Synchronous Buck 2 Cells Li-ion Charger

### PINOUT

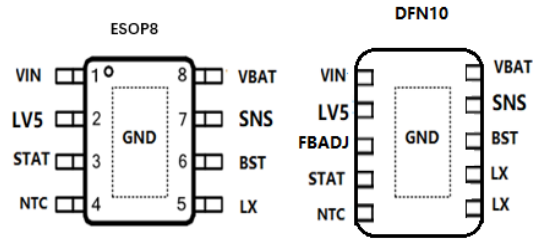

### PIN FUNCTIONS

Pin Name	PIN Number		Description
	ESOP8	ESSOP10	
LX	5	6,7	Switch pin. Connect to external inductor.
BST	6	8	Internal charge pump boost pin.
STAT	3	4	Open-Drain Charge Status Output. When the battery is charging, this pin is pulled low by an internal N-channel MOSFET. When the BC912 detects an under voltage lockout condition, STAT is forced high impedance.
NTC	4	5	NTC (Negative Temperature Coefficient) Thermistor Input. This pin senses the Temperature of the battery pack and stops the charger when the temperature is out of range. Connect to GND for disabling
VBAT	8	10	Battery pin.
SNS	7	9	Detecting pin of charge current.
LV5	2	2	5V LDO output PIN. Connect a minimum 1uF capacitor between this PIN and GND.
VIN	1	1	Positive Supply Voltage Input. Decouple with a 10μF or larger surface mounted
GND	ePAD	ePAD	Ground.
FBADJ		3	CV adjust PIN. Connect resistor to GND increase CV voltage. Connect resistor to VBAT decrease CV voltage.

### 3A Synchronous Buck 2 Cells Li-ion Charger

## ELECTRICAL CHARACTERISTICS

(TA=25°C, VIN = 5V, unless otherwise noted)

Symbol	Parameter	Condition	Min	Typ	Max	Units
V <sub>IN</sub>	Adapter/USB Voltage		4		22	V
I <sub>CC</sub>	Input Supply Current	Standby Mode (Charge Terminated)		1		mA
V <sub>FLOAT</sub>	Regulated Output (Float) Voltage	FBADJ floating		8.4		V
V <sub>RS</sub>	Program Charging Current (For RS to BAT)	V <sub>TRIKL</sub> < V <sub>BAT</sub> < V <sub>FLOAT</sub>		50		mV
I <sub>BAT</sub>	BAT Pin Current	R <sub>SNS</sub> =50mΩ,		1000		mA
		R <sub>SNS</sub> =25mΩ,		2000		mA
		Standby Mode		4		μA
I <sub>TRIKL</sub>	Trickle Charge Current	V <sub>BAT</sub> < V <sub>TRIKL</sub> ,		100		mA
		V <sub>BAT</sub> < 2.3V		20		mA
V <sub>TRIKL</sub>	Trickle Charge Threshold	R <sub>SNS</sub> =50mΩ, V <sub>BAT</sub>		5.6		V
V <sub>TRHYS</sub>	Trickle Charge Hysteresis	R <sub>SNS</sub> =50mΩ		100		mV
V <sub>STAT</sub>	STAT Pin Output Low	I <sub>STAT</sub> =5mA			0.5	V
I <sub>STAT</sub>	STAT Pin Weak Pull-Down	V <sub>STAT</sub> =5V			5	uA
ΔV <sub>REC</sub>	Recharge Battery Threshold	V <sub>FLOAT</sub> -V <sub>RECHRG</sub>		150		mV
T <sub>LIM</sub>	Junction Temperature in Constant			150		°C
I <sub>TERM</sub>	C/10 Terminal Current	R <sub>SNS</sub> =50mΩ		100		mA
VIN UVLO	Under Voltage Lockout of VIN	V <sub>IN</sub> rising		4		V
		V <sub>IN</sub> falling		3.8		V
VIN OVP	VIN over voltage protect	VIN rising		25		V
		hysteresis		1		
V <sub>NTC-H</sub>	High Temperature Protection Threshold Voltage	Battery Temperature rising		30		%V <sub>LV5</sub>
V <sub>NTC-L</sub>	Low Temperature Protection Threshold Voltage	Battery Temperature falling		70		%V <sub>LV5</sub>
F <sub>OSC</sub>	Frequency			500		KHz

## 3A Synchronous Buck 2 Cells Li-ion Charger

### APPLICATION INFORMATION

BC912 is a wide range  $V_{IN}(4V-20V)$ , 3A 1cell asynchronous boost Li-Ion battery charger integrates 500KHz switching frequency and full protection functions. The charge current can be programmed up to Max 2.5A by using the external resistor for different portable applications and indicates the charger current information simultaneous. In constant current mode, the charge current is set by the external sense resistor  $RSNS$  and an internal 50mV reference;

$$I_{BAT} = V_{RS} / RSNS = 50mV / RSNS$$

When the battery voltage approaches the programmed float voltage, the charge current will start to decrease. When the current drops to 10% of the full-scale charge current, an internal comparator turns off charging is terminated

### Input Source Qualification

After REGN amplifier powers up, the BC912 checks the current capability of the input source. The input source has to meet the  $V_{REG} > 1V$  to enable the chip

### Battery Temperature Detection

The BC912 continuously monitors temperature by measuring the voltage between the NTC and GND pins. A negative or a positive temperature coefficient thermistor (NTC, PTC) and an external voltage divider typically develop this voltage. The BC912 compares this voltage against its internal  $V_{NTC-H}$  and  $V_{NTC-L}$  thresholds to determine if charging is allowed. The temperature sensing circuit is immune to any fluctuation in  $LV5$ , since both the external voltage divider and the internal thresholds ( $V_{NTC-H}$  and  $V_{NTC-L}$ ) are referenced to  $LV5$ .

The resistor values of  $R1$  and  $R2$  are calculated by the following equations:

For NTC Thermistors:

$$K1 (V_{NTC-H}) = 30\%,$$

$$K2 (V_{NTC-L}) = 70\%.$$

### Automatic Recharge

Once the charge cycle is terminated, the BC912 continuously monitors the voltage on the BAT pin using a comparator with a 1.8ms filter time ( $t_{RECHARGE}$ ). A charge cycle restarts when the battery voltage falls below 8.1V (which corresponds to approximately 80% to 90% battery capacity). This ensures that the battery is kept at or near a fully charged condition and eliminates the need for periodic charge cycle initiations.

Where  $R_{TL}$  is the low temperature resistance and  $R_{TH}$  is the high temperature resistance of thermistor, as specified by the thermistor manufacturer.  $R1$  or  $R2$  can be omitted if only one temperature (low or high) setting is required. Applying a voltage between the  $V_{NTC-H}$  and  $V_{NTC-L}$  thresholds to pin NTC disables the temperature-sensing feature.



## 3A Synchronous Buck 2 Cells Li-ion Charger

### CV adjustment

Battery termination voltage default set to 8.4V. If other CV voltage wanted, the follow equations change the CV voltage.

If increase CV voltage, connect a resistor from FBADJ to GND. the increased voltage determined by:

$$\Delta V = \frac{2.1}{R_{trim}} * R_{divup}$$

If decrease CV voltage, connect a resistor from battery to FBADJ, the decreased voltage determined by

$$\Delta V = \frac{V_{CV} - 2.1}{R_{trim}} * R_{divdown}$$

Rdivup=156K

Rdivdown=156K/3 for 2cell

### Shutdown

The BC912 can be shut down by pulling the NTC pin to VIN. When the NTC pin is released, the internal timer is reset and a new charge cycle starts.

### Inductor Selection

A operating frequency was chosen for the buck switcher in order to minimize the size of the inductor. However, take care to use inductors with low core loss at this frequency. To calculate the inductor ripple current:

### Charge Status Indicator (STAT)

The charge status output has two different states: strong pull-down (~5mA) and high impedance. The strong pull-down state indicates that the BC912 is in a charge cycle. Once the charge cycle has terminated, the pin state is determined by under voltage lockout conditions. High impedance indicates that the charge cycle complete.

### Layout Considerations

Switch rise and fall times are kept under 5ns for maximum efficiency. To minimize radiation, the SW pin and input bypass capacitor leads (between VIN and GND) should be kept as short as possible. A ground plane should be used under the switching circuitry to prevent inter plane coupling. The Exposed Pad must be connected to the ground plane for proper power dissipation. The other paths contain only DC and/or 500KHz tri-wave ripple current and are less critical. With the exception of the input and output filter capacitors (which should be connected to GND) all other components that return to ground.



3A Synchronous Buck 2 Cells Li-ion Charger

PACKAGE INFORMATION

DFN10

标注	尺寸	最小(mm)	标准(mm)	最大(mm)	标注	尺寸	最小(mm)	标准(mm)	最大(mm)
A		0.70	0.75	0.80	E		2.90	3.00	3.10
A1		-	-	0.05	D2		1.60	1.70	1.80
A3		0.203 REF			E2		2.30	2.40	2.50
b		0.18	0.23	0.28	e		0.50 TYP		
D		2.90	3.00	3.10	L		0.35	0.40	0.45

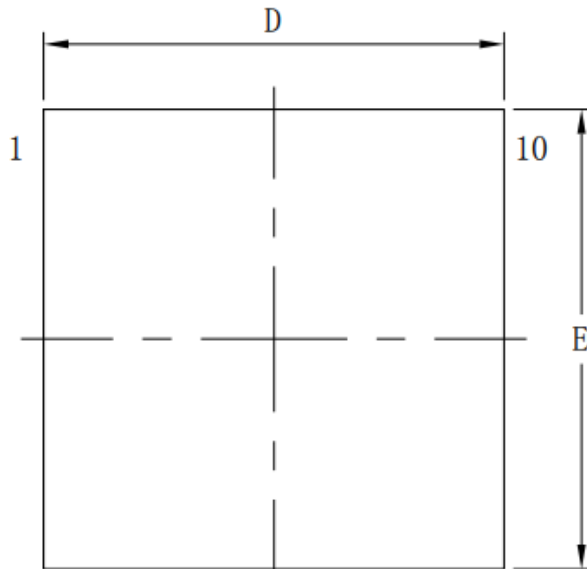

Top View

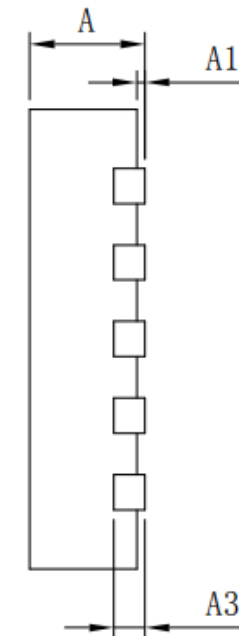

Side View

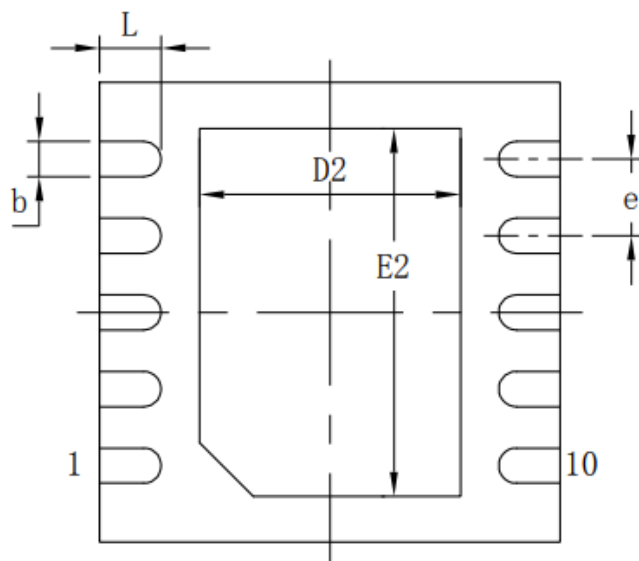

Bottom View





3A Synchronous Buck 2 Cells Li-ion Charger

ESOP8

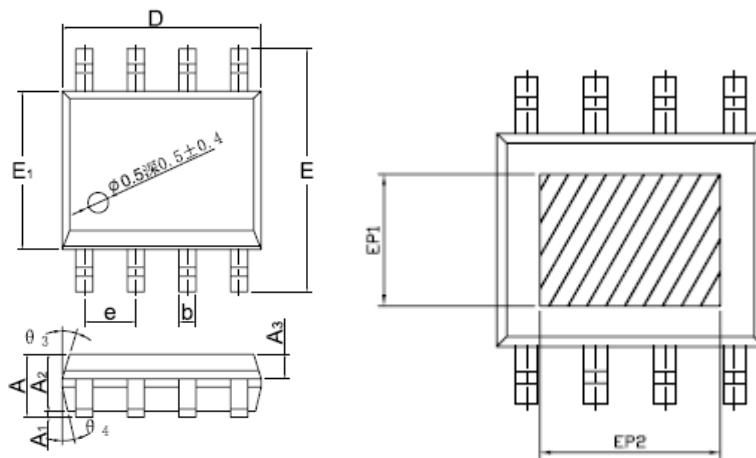

DIMENSIONS IN MILLIMETERS

SYMBOL	MIN	NOM	MAX
A	1,35	1,55	1,75
A <sub>1</sub>	0,00	—	0,10
A <sub>2</sub>	1,25	1,40	1,65
A <sub>3</sub>	0,50	0,60	0,70
b	0,39	—	0,49
b <sub>1</sub>	0,28	—	0,48
c	0,10	—	0,25
c <sub>1</sub>	0,10	—	0,23
D	4,80	4,90	5,00
E	5,80	6,00	6,20
E <sub>1</sub>	3,80	3,90	4,00
e	1,27BSC		
L	0,45	—	1,00
L <sub>1</sub>	1,04REF		
L <sub>2</sub>	0,25BSC		
R	0,07	—	—
R <sub>1</sub>	0,07	—	—
h	0,3	0,4	0,5
$\theta$	0°	—	8°
$\theta_1$	11°	17°	19°
$\theta_2$	11°	13°	15°
$\theta_3$	15°	17°	19°
$\theta_4$	11°	13°	15°
EP1	2,40	—	—
EP2	3,30	—	—

